

## INSTALLATION INSTRUCTIONS

**K4730J-BW**  
**SINGLE HANDLE**  
**Lavatory Faucet**
***Tools***

For safety and easy faucet replacement, San-Ei recommends the use of the following helpful tools:

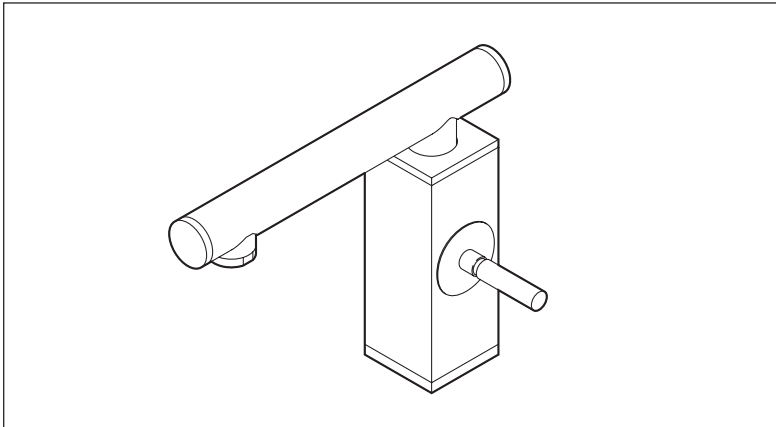

SAFETY GLASSES

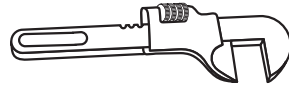

PIPE WRENCH



PLIERS



CHANNEL LOCKS

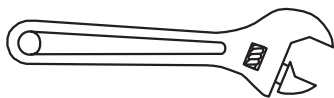

ADJUSTABLE WRENCH

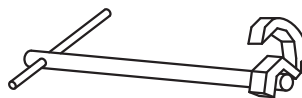

BASIN WRENCH

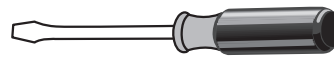

PHILLIPS SCREWDRIVER



FLASHLIGHT

***About This Manual***
**Keep Instructions for Future Reference**

Thank you for purchasing San-Ei's quality faucet.

With simple care and maintenance, it will provide you with many years of reliable performance.

Please read instructions before installation.

**TIPS FOR REMOVAL OF OLD FAUCET**

**CAUTION:** Always turn water OFF before removing existing faucet or disassembling the faucet.

Open the faucet handles to relieve water pressure and ensure that complete water shut-off has been accomplished.

(Complies with ASME A112.18.1 and CSA B 125)

# PARTS LIST

The structure shown is an illustration.

Please use this structure for better understanding.

Please ask the part of the selling agent or our company of purchase, in case that the pottery part cracked.

The standard color is White (JW).

The others become the production that receives.

As for the order, please attach the color number at the end of the article No.

Color Number	Name
JW	White
JI	Ivory
JG	Green
JD	Black
JR	Red

**K4730J-BW**  
**General Description**

1. Cap
2. Lever
3. Coil Spring
4. Lever Support
5. Plate
6. Seat Packing
7. Cartridge Holder
8. Ceramic Cartridge
9. Makeup Plate
10. Body Cover
11. Valve Body
12. Seat Packing
13. Rubber Packing
14. Metal Washer
15. Lock Nut
16. Flex Tube
17. Fastener Clip
18. Lock Cover
19. Fastener Adapter
20. Rubber Packing
21. Outlet Neck
22. Set Screw at Rod End
23. Outlet Neck Holder
24. Outlet Nipple
25. Outlet Neck Spacer
26. Outlet Cover Cap
27. Outlet Pipe Cover
28. Outlet Pipe
29. Filter Nipple
30. Filter Spacer
31. Packing
32. Aerator
33. Aerator Body

34. Fastener Adapter (male)

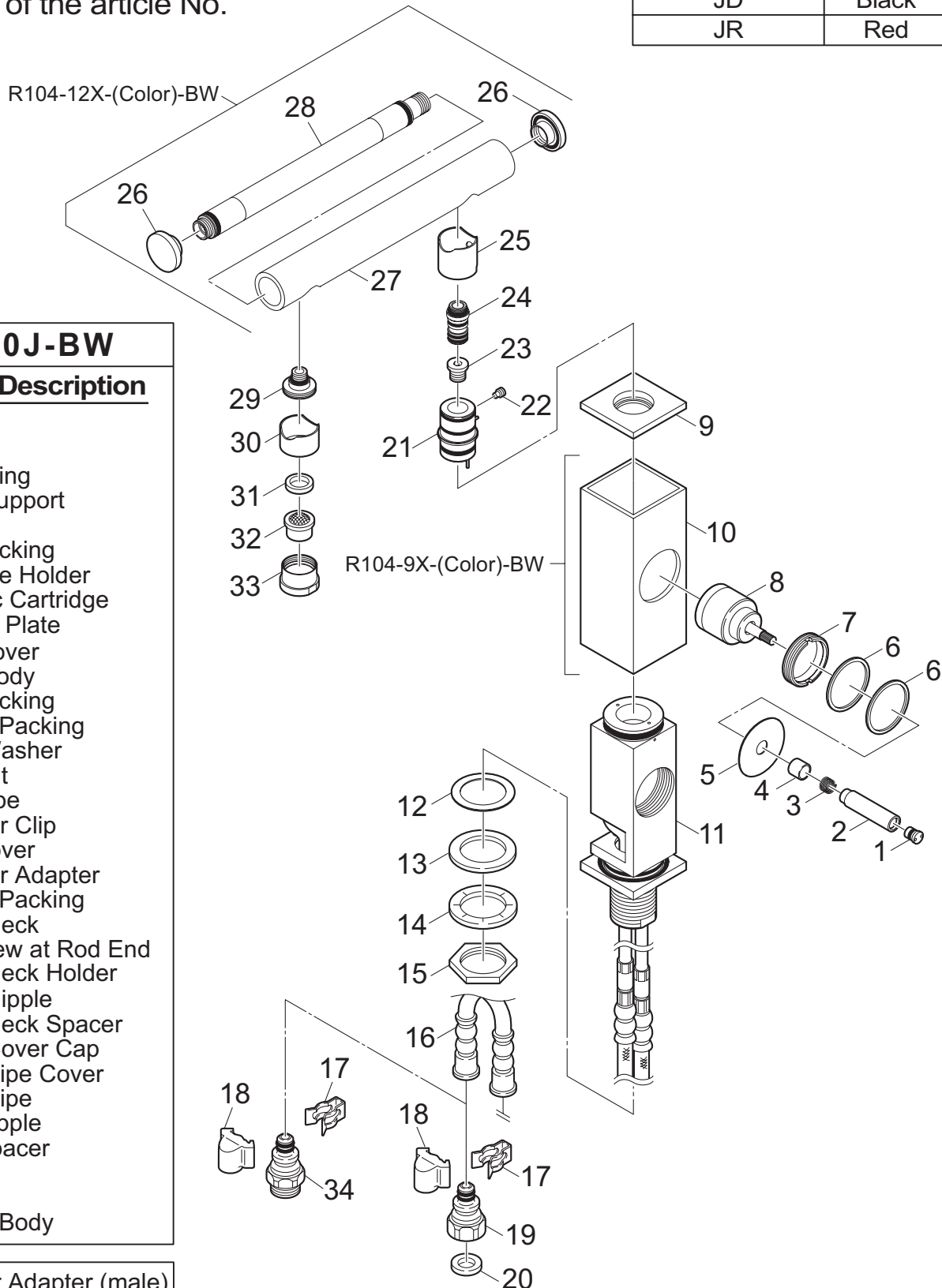

## OPERATION

### Lavatory Faucet K4730J-BW

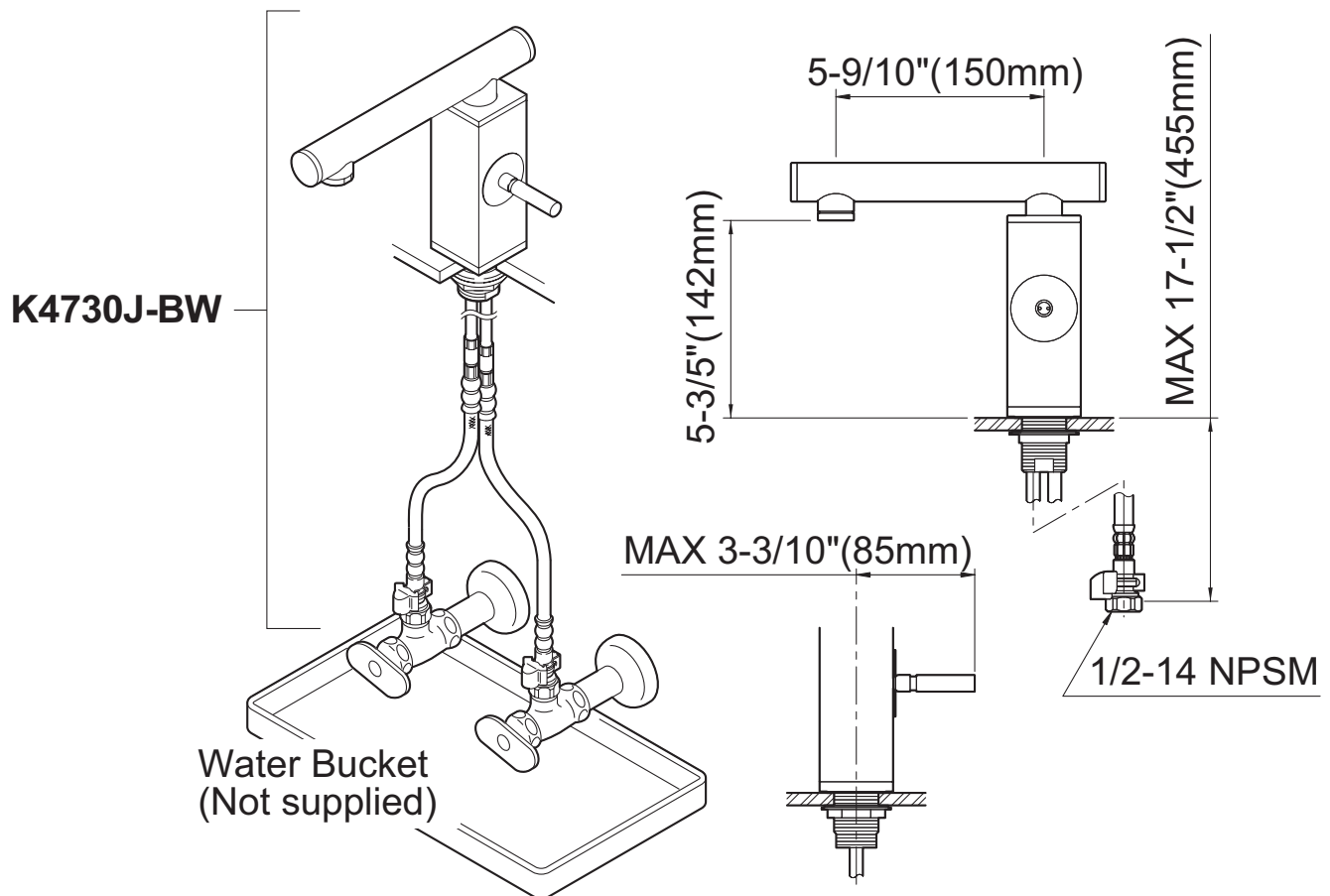

**NOTE :** Maximum deck thickness for installation is 1-1/5" (30mm).  
Hole size for installation is between 1-3/10" (33mm) to 1-2/5" (35mm).

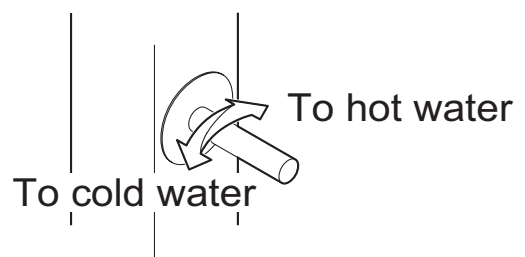
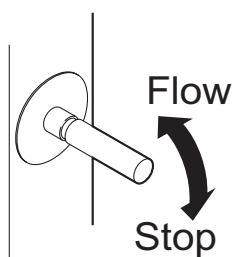

### **PRIOR TO INSTALLATION**

Prior to installing new faucet, install the items listed below:

- \* Lavatory sink
- \* Drain Line

#### **Important !**

- \* All plumbing is to be installed in accordance with applicable codes and regulations.
- \* Flush all water lines prior to making connection.

# INSTALL FAUCET

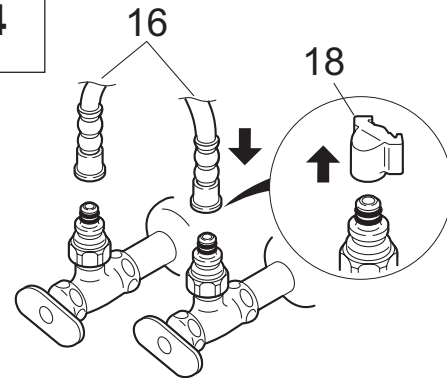
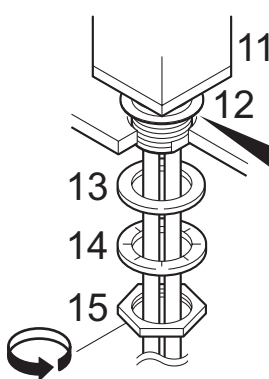
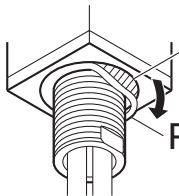
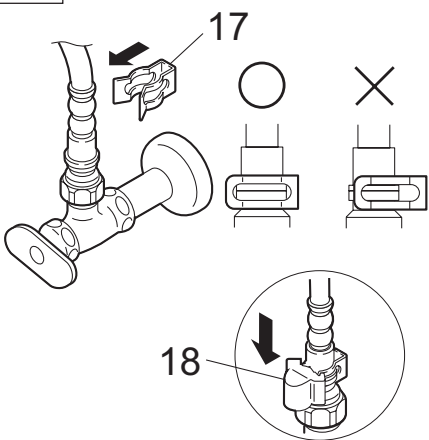
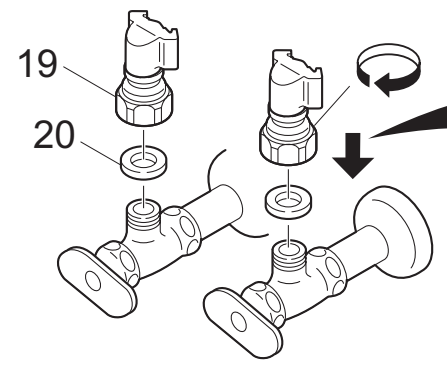
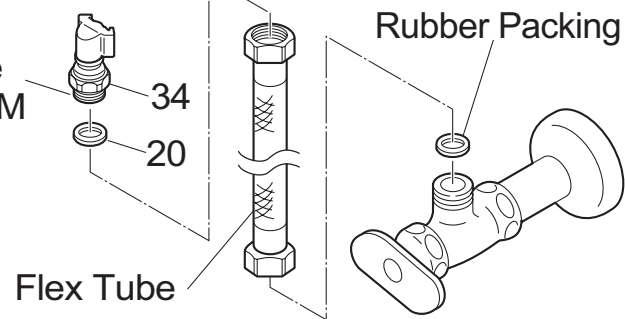
<p><b>1</b></p>  <p>Sink hole dia Between 1-3/10"(33mm) to 1-2/5"(35mm)</p> <p>MAX 1-1/5"(30mm)</p>	<p><b>4</b></p> 
<p><b>2</b></p>  <div data-bbox="483 742 994 1230" style="border: 1px solid black; padding: 5px;"> <p><b>(Caution !)</b> Remove a protective tape attached in the back of the packing. Then, install the faucet body to be fixed.</p>  <p>Seat Packing Protective Tape</p> </div>	<p><b>5</b></p> 
<p><b>3</b></p>  <p><b>NOTE :</b> Thread Size 1/2-14 NPSM</p>	<p>To extend both cold water and hot water supply tubes.</p> <p>In case the supply tubes from the faucet cannot reach to the stop valves for connection, please use the fastener adaptor (male thread type) to extend the supply tube from the stop valves. (Flex supply tube not supplied.)</p>  <p>Thread Size 1/2-14 NPSM</p> <p>34 20</p> <p>Flex Tube</p> <p>Rubber Packing</p>

## 1. Measurement

Be sure that mounting space is clean and dry.  
Please make sure the diameter of the mounting hole before installation.  
(Please pay attention not to bend the hose tube excessively.)

## 2. Install faucet

The front side of the spout should face you. Then, make tightening the lock nut(15).

(counterclockwise) Please don't forget to put a seat packing(12), rubber packing(13), and metal washer(14), between unit body(11) and lock nut(15).

## 3. Install "quick fastener" adapter

Please install the adapters(19) onto the each stop valves(not supplied).

Please don't forget packing(20) between angle stop valve and adapter(19).

## 4. Remove lock cover

Remove the lock cover(18) from the adapter(19).

## 5. Connection

Connect flexible tube(16) from the faucet with adapter(19). Then, please clip them With fastener clip(17) until there make a "click sound". After making sure the connection is done in perfect, please attach the lock cover(18) onto a fastener clip(17).

## 6. Work testing

Please go to "Flushing instruction" section before starting to use faucet.

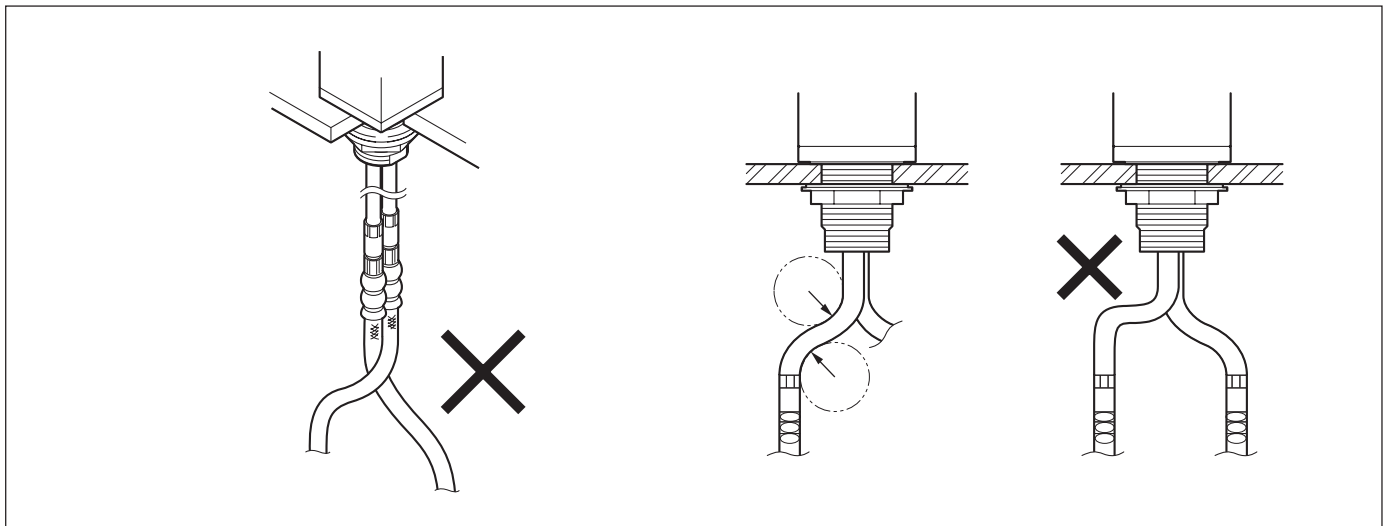

## CAUTION!

Please pay attention to the following points when installing the faucet.

- \* Install the supply tube to the cold and the hot supply side properly. Don't tangle the tube when installing because the connection will become loose when the strong water pressure is added.
- \* Keep enough distance between the tubes. Without the distance, the tube will rub each other and it will cause damage to the tube.
- \* When bending the tube, keep the radius more than 50mm. Excessive bending will cause damage to the tube.
- \* When installing the faucet, do not excessively bend the ending part of the tube.
- \* "C" mark on the supply tube stands for cold water supply use.
- \* "H" mark on the supply tube stands for hot water supply use.

## CARTRIDGE REPLACEMENT

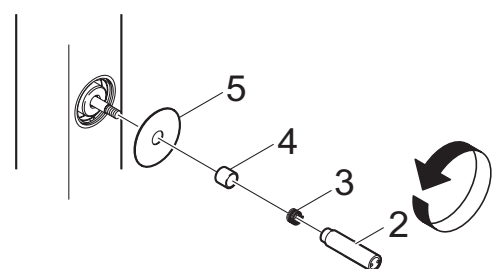
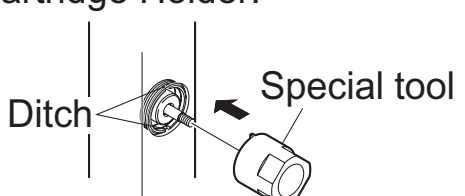
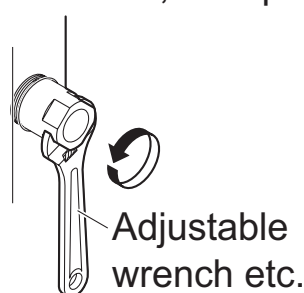
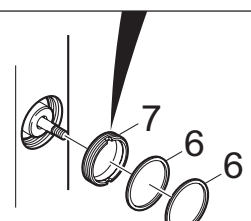
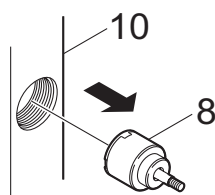
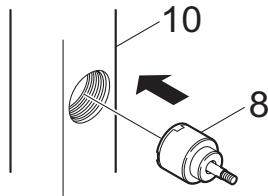
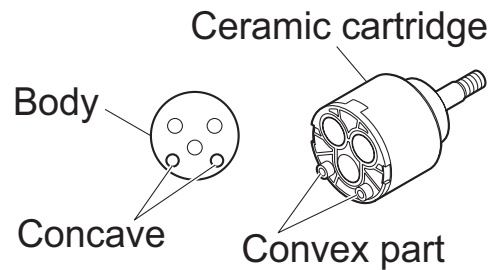
<div style="border: 1px solid black; padding: 5px; margin-bottom: 10px;"> <p style="text-align: center; font-weight: bold; font-size: 24px;">1</p>  </div> <div style="border: 1px solid black; padding: 5px; margin-bottom: 10px;"> <p style="text-align: center; font-weight: bold; font-size: 24px;">2</p> <p style="text-align: center;">The cartridge Holder is a feretory.</p> <p>① A special tool is set in the ditch of the cartridge Holder.</p> <div style="text-align: center;">  </div> <p>② A special tool is placed with the adjustable wrench etc, and spends.</p> <div style="text-align: center;">  </div> </div> <div style="text-align: center; margin-top: 10px;">  </div>	<div style="border: 1px solid black; padding: 5px; margin-bottom: 10px;"> <p style="text-align: center; font-weight: bold; font-size: 24px;">3</p>  </div> <div style="border: 1px solid black; padding: 5px; margin-bottom: 10px;"> <p style="text-align: center; font-weight: bold; font-size: 24px;">4</p>  </div> <div style="border: 1px solid black; padding: 10px; margin-top: 10px;"> <p style="text-align: center;">At assembly</p> <p>The convex part on the back of a ceramic cartridge is matched to the concave portion in the trunk.</p> <div style="text-align: center;">  </div> </div>
---	---

**Caution!**

Always turn water OFF before removing the cartridge. Open the handle to relieve water pressure and ensure that water shut-off has been accomplished.

1. The lever(2) is removed with pliers.
2. The cartridge cover is removed with a special tool.
3. Remove an old ceramic cartridge(8) with pliers and replace a new ceramic cartridge(8).
4. To reassemble, reverse the previous steps.

## ***FLUSHING INSTRUCTIONS***

**IMPORTANT!** : Pipe chips, sand, stones and other solid found in new and renovated plumbing can damage the ceiling of the cartridge and cause leaks to avoid damage,

**DO NOT TURN ON SUPPLY VALVES** until instructed below.

1. After installing and connecting your new faucet, turn on in the full cold position (handle pointing to the right) and turn on the cold supply for 15 seconds.
2. Without closing the handle, turn to the full hot position (handle pointing to the left) and turn on the hot supply for 15 seconds.
3. Close the handle, then using a towel unscrew the aerator from the end of the spout and clean the aerator.
4. Using a towel replace the aerator and check the system for leaks.

## ***TROUBLESHOOTING***

**TO CORRECT REVERSED HOT AND COLD POSITIONS :**

1. Shut off both stop valves. Then, open faucet handles to relieve water pressure that complete water shut-off has been accomplished.
2. Remove a lock cover and fastener clip in order. Then, remove the flex supply tubes.  
Re-connect each flex supply tubes into different supply stop valves.  
(An excessive bending will cause leaking and damage to the tubes.)  
Then, attach the fastener clip and lock cover after connecting the supply tubes.
3. Re-installing and connecting, turn on both cold and hot supply.
4. Turn on in the full position, make sure that the each positions keeps correct way & make sure any water leakage.

## ***MAINTENANCE***

### **Care and Cleaning of Chrome and Special Finishes**

Do not use abrasive or chemical cleaners (including chlorine bleach) to clean faucets as they may dull the luster and attack the chrome or special decorative finishes. Use **ONLY** soap and water, then wipe dry with clean cloth or towel. While cleaning the bathroom tile, the faucet should be protected from any splattering of cleaner. Acids and cleaning fluids will discolor or remove chrome plating.

## LIMITED WARRANTY

SAN-EI products have been manufactured under the highest standards of quality and workmanship, and warrants to the original consumer purchaser that its products are free of defects in material and workmanship.

1. Ceramic cartridges and PVD finishes carry a **limited lifetime warranty** to the **Original Consumer Purchaser** for as long as that consumer purchaser owns his/her/their home. All other parts are warranted for **2 years** after the date of purchase.

2. SAN-EI warrants to the **Commercial Purchaser** that their products, purchased for commercial, industrial or other business use, are free from defects of workmanship and materials for a period of **1 year** after the date of purchase.

All warranties are to the original purchaser and require presentation of original sales receipt.

Warranty is not transferable. ***During the warranty period, SAN-EI will, at its option, repair or replace any part or parts which have been determined to be defective if returned at purchaser's expense. This shall be the sole remedy available under this warranty. Defects or damage caused by the use of other than genuine SAN-EI parts are not covered by this warranty. Installation or any other labor charges associated with the repair or re-installation of SAN-EI products is not covered by this warranty.*** Damage due to improper installation, misuse, poor maintenance practices, accident, alcohol, or other organic solvents, or use in any manner

contrary to the written instructions provided, whether done by contractor, service company, or end user, are excluded from this warranty. Some states, provinces and nations do not allow the exclusion or limitation of incidental or consequential damages, so the above limitations or exclusions may not apply to you. This warranty gives you specific legal rights and you may also have other rights which vary from state to state, province to province, nation to nation.

SAN-EI will advise you of the procedure to follow in making warranty claims. Simply write to explain the defect and include product instruction manual, along with original proof of purchase receipt showing the store name, address and date of purchase.

Be sure to include your name, address and telephone number.

## USER INFORMATION

Faucets made of leaded brass alloys may contribute small amounts of lead to water that is allowed to stand in contact with the brass.

The amount of lead contributed by any faucet is highest when the faucet is new.

The following steps may reduce potential exposure to lead from faucets and other parts of the plumbing system.

\*Always run the water for a few seconds prior to use for drinking or cooking.

\*Use only cold water for drinking or cooking.

\*If you wish to flush the entire plumbing system of water that has been standing in the pipes or other fittings.

Run the cold water until the temperature of the water drops, indicating water coming from the outside main.

\*If you are concerned about lead in your water, have your water tested by a certified laboratory in your area.

## CONTACT

In the United States and Canada, please kindly call our office number for answers to any product, installation, or warranty questions.

**- Importer / Master Distributor -**

**Sanicor International Corp.**

2116 South Grand Ave., Santa Ana, CA 92705

Tel : 714-540-1110 Fax : 714-540-1171